



- Quality
- Value
- Service

**Tech
Reference**

Hygienic Solutions at Work

Hands Free Roll Towel Dispenser

- Code 109-70W:** White epoxy powder finish
Code 109-70S: Stainless steel, 304 no. 4 finish
Code 109-70P: Smoked polycarbonate cover with metal back.

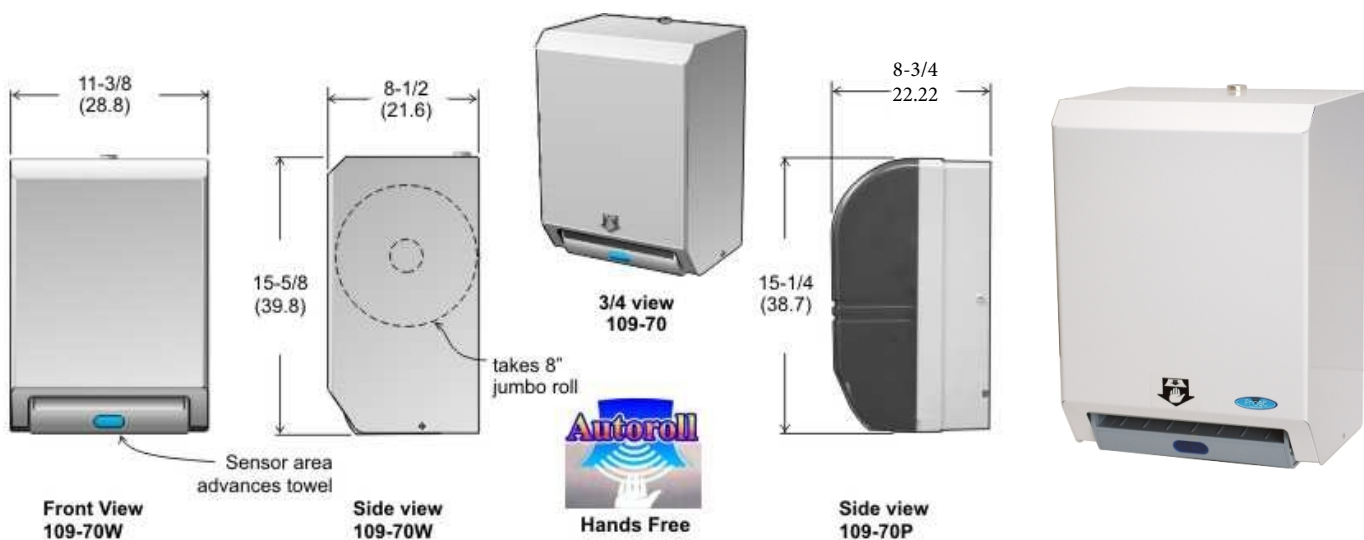

Specifications:

Site location: All metal construction is ideal for high traffic areas where vandalism is a concern.

Dispensing: The 109-70 is designed to dispense Jumbo 8" diameter (2-1/2" reserve roll) x 8" wide roll towels. Large detection zone senses hand when placed in a natural position under dispenser to deliver a towel length range of 6-9 inches (15-23cm).

Features: Towel delivery is quiet and uniform. Hands free dispenser reduces paper flow, and provides maximum hygiene. Operates with 4 "D" size alkaline batteries or plug in AC adaptor. 4 alkaline batteries have been independently tested and found to provide 35,000 hand dries. Comes with keyed tumbler lock to reduce pilferage and vandalism. Front loading for easy service and maintenance.

Code 109-70S: All welded construction of 22 gauge no. 4 brushed finish stainless steel.

Code 109-70P: Tough polycarbonate vandal resistant smoked transparent door.

Shipping Weight: Code 109-70W&S: 12 lbs. (5.3 kg), Code 109-70P: 7 lbs. (3 kg)

Installation: For unrestricted access, bottom of unit to floor should not exceed 44" (111.7). Mounting screws provided.

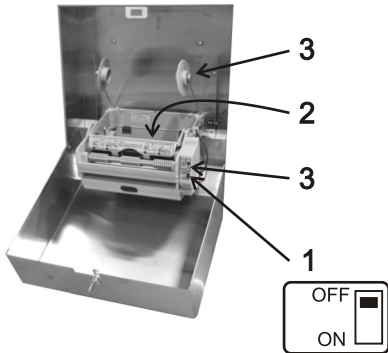

Steps

- 1** Insure unit is turned off. The unit must always be turned off while loading paper.
- 2** Install batteries, 4 "D" batteries (Alkaline, for best results). For AC units connect adaptor.
- 3** Load paper, set paper length.
(See Adjust paper length below, figure 1)

2

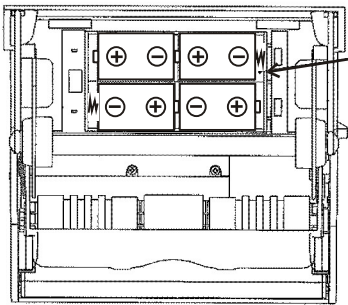

Front of unit

Battery Installation

Remove battery cover. Install batteries taking care to arrange the polarities as shown. Insure all batteries are the same brand, do not mix used batteries with new batteries. Replace battery cover.

AC adaptor

The unit will run on both batteries and the AC adaptor. No power will be drawn from the batteries while the AC adaptor is plugged in. Insure all connections are secure and fully engaged.

AC adaptor specifications:

Input 120v AC, output 6v DC 500ma

3

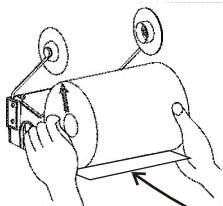

Paper loading
Insure the unit is turned off.
Load paper to feed from the bottom.

(A)

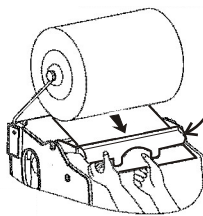

Lift the transfer bar and slip the paper under.

(B)

Lower the transfer bar onto the paper pinching it slightly.

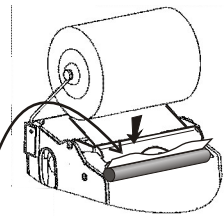

(C)

(D)

Turn on the unit. Wait for the paper length indicator light to stop flashing (figure 1). Place your hand under the blue sensor area to advance the paper. If the paper fails to advance, turn the power off, this resets the unit, then turn the power on again. Place your hand under the sensor to advance the paper. Tear off the paper. Close and lock door.

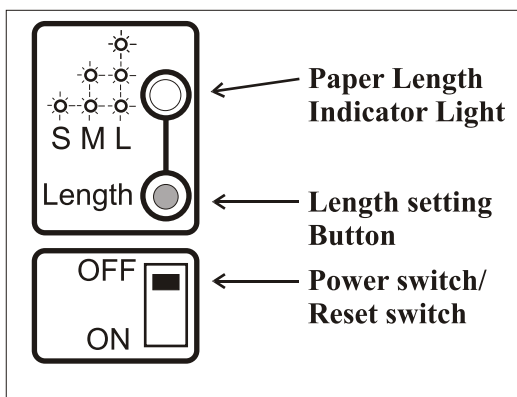

Figure1.

Adjusting paper length:

Hold down the length setting button and observe the number of flashes on the indicator light. One flash is short, two is medium and three is longest length of paper.

Interpreting the indicator light:

- A constant red indicates that the motor has advanced and the paper has not been torn off. The unit will not advance or dispense any more paper until the paper is torn or the unit is reset.

- Flashing once per second indicates that the batteries are and need to be replaced. The unit will continue to operate. Paper lengths will vary when the batteries are low.